









handle with masking plate standard illuminated size 75x 75, for shaft 8x 8, test-0-I, handle size 45mm accessory for 3KD size 1 and 2, 3KF size 1

Model		
product brand name	SETRON	
product designation	handle with masking plate	
design of the product	standard with tolerance compensation	
design of handle	Gray	
design of the door lock system	Door interlocking	
size of cross-section of the shaft of door-coupling rotary operating mechanism	8x8 mm	
size format of the masking frame of door-coupling rotary operating mechanism	75x 75 mm	
length of handle	45 mm	
protection class IP	IP65	
suitability for use	for 3KD size 1 and 2, 3KF size 1	
Product details		
product description	with illumination	
product component		
• extension shaft	No	
• handle for emergency-OFF function	No	
product feature lockable	Yes	
display version for switch position indicator	test-0-I	
Mechanical Design		
height	84 mm	
width	84 mm	
depth	80 mm	
net weight	140 g	
Approvals Certificates		
General Product Approval	Declaration of Conformity	Marine / Shipping
		
		
UL	VDE	EG-Konf.
LRS		
other		Environment

[Confirmation](#)

[Miscellaneous](#)

[Environmental Con-
firmations](#)

Further information

Siemens has decided to exit the Russian market (see here).

<https://press.siemens.com/global/en/pressrelease/siemens-wind-down-russian-business>

Siemens is working on the renewal of the current EAC certificates.

Please contact your local Siemens office on the status of validity of the EAC certification if you intend to import or offer to supply these products to an EAC relevant market (other than the sanctioned EAEU member states Russia or Belarus).

Information on the packaging

<https://support.industry.siemens.com/cs/ww/en/view/109813875>

Information- and Downloadcenter (Catalogs, Brochures,...)

<http://www.siemens.com/lowvoltage/catalogs>

Industry Mall (Online ordering system)

<https://mall.industry.siemens.com/mall/en/en/Catalog/product?mlfb=8UD1771-2CF01>

Service&Support (Manuals, Certificates, Characteristics, FAQs,...)

<https://support.industry.siemens.com/cs/ww/en/ps/8UD1771-2CF01>

Image database (product images, 2D dimension drawings, 3D models, device circuit diagrams, ...)

http://www.automation.siemens.com/bilddb/cax_en.aspx?mlfb=8UD1771-2CF01

CAX-Online-Generator

<http://www.siemens.com/cax>

Tender specifications

<http://www.siemens.com/specifications>

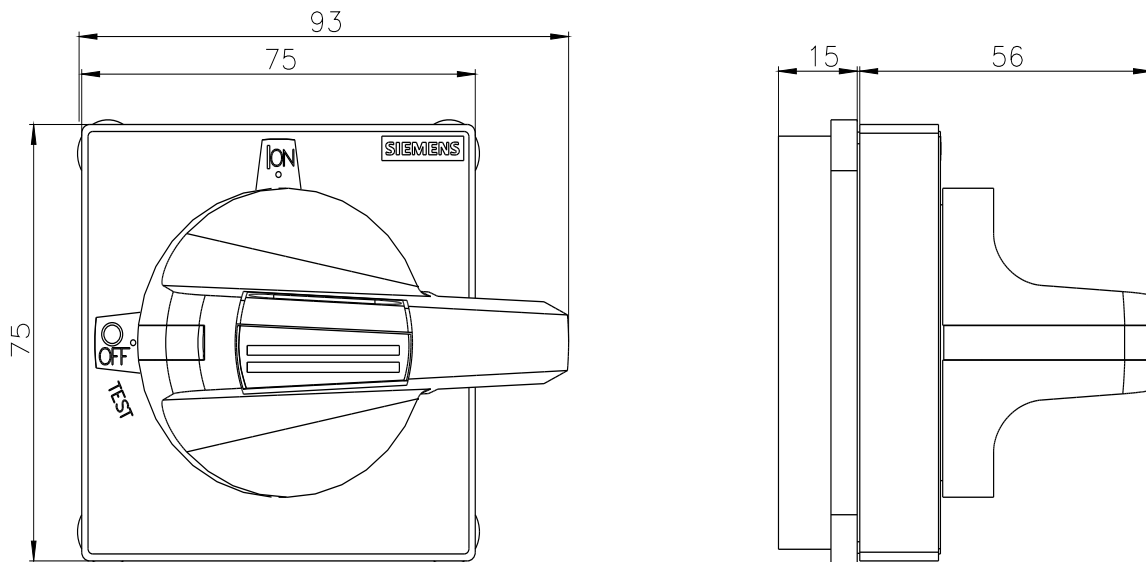

last modified:

7/29/2022

